

Human Machine Interface

User Manual

Version:HMI V3.0



SHANGHAI YINGTONG ELECTRIC CO., LTD.

Tel: +86-21-33712042

Web: www.yt-electric.com/en

E-mail: eng@yt-electric.com

Contents

1. Functional Description & Mounting Dimensions.....	2
1.1 Functional Description.....	2
1.2 Mounting Dimensions.....	2
2. Data Display & Main Interface.....	4
2.1 Main Interface.....	4
2.2 Module Data Display.....	5
2.3 Main Menu.....	6
3. Parameter Setting.....	7
3.1 Main Parameter Setting.....	7
(1) Module Number.....	8
(2) CT Ratio Setting.....	8
(3) Selection of External CT Location.....	8
(4) Broadcast address.....	8
(5) Power On/Off.....	9
(6) Save Parameter.....	9
3.2 Module Parameter Setting.....	9
(1) Compensation Mode (priority).....	10
(2) Reactive Compensation Switch.....	11
(3) Harmonic Compensation Switch.....	11
(4) Imbalance Compensation Switch.....	11
(5) Peak Current Setting.....	11
(6) Capacity Compensation Ratio.....	11
(7) Target Power Factor.....	12
(8) A/B/C Phase Reactive Power Output.....	12
(9) Harmonic Number Compensation Ratio.....	12
(10) Save Parameter.....	13
4. Event Log.....	14
5. System Setting.....	15

Instructions for use: Before parameter setting, the operator must be trained and qualified by the company before they can operate.

1. Functional Description & Mounting Dimensions

1.1 Functional Description

The LCD controller is used in the LCD screen of the active power filter device (APF), communicates with the APF module through the RS485 interface, and can set the parameters of the module and view the data.

Up to 6 modules can be connected to this LCD interface, without the capacitor control function.

1.2 Mounting Dimensions

The controller is installed on the cabinet, the cut-out size is 192mm x 138mm, and its dimensions are shown in the figure below:

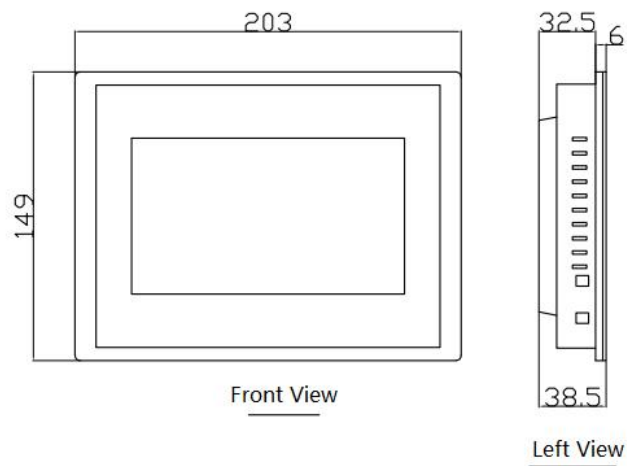

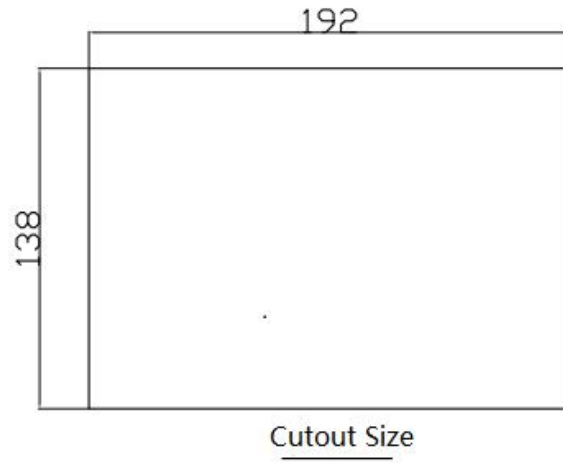

Figure 1-1 Controller Outline Size & Cutout Size

2. Data Display & Main Interface

2.1 Main Interface

After the LCD screen is powered on, it enters the main interface to display, as shown in Figure 2-1. The main interface displays real-time data of the power system, including voltage, current, power factor, voltage and current distortion rate, load imbalance of the grid side and the load side, etc. Power-on and power-off buttons can simultaneously turn on/off each module controlled by the LCD screen. The operation status of each module is displayed at the bottom.

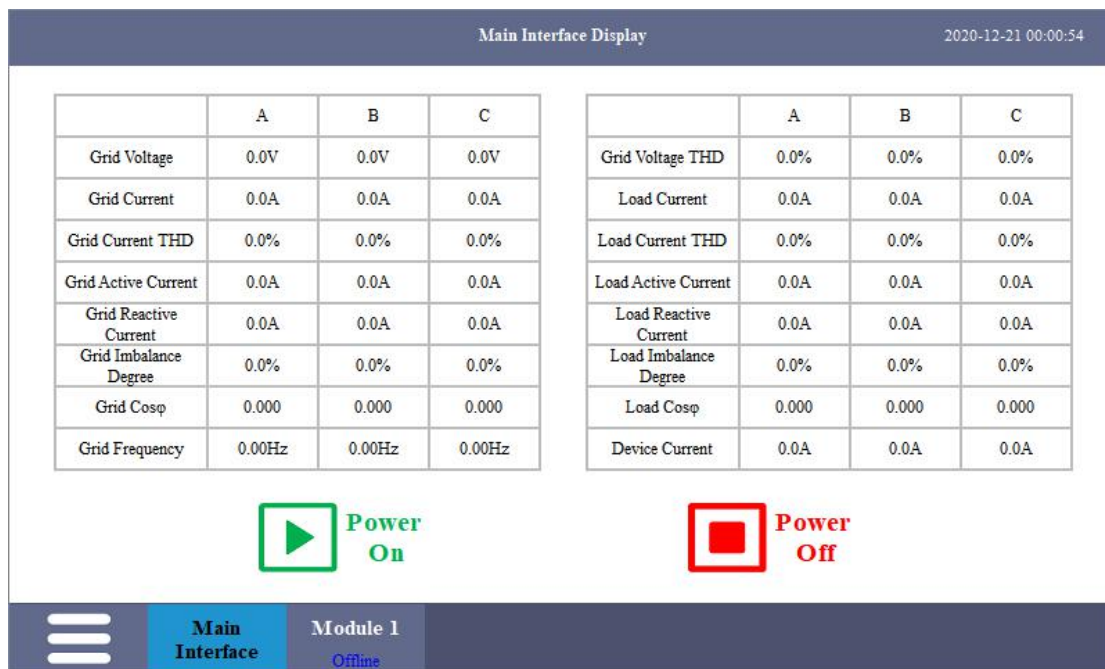

Figure 2-1 Boot Main Interface

If the LCD screen controls multiple modules, a drop-down box will appear in the upper left corner of the interface, and you can select the data display mode of the main interface (the data of each module is displayed cyclically or only the data of the specified module is displayed), as shown in Figure 2-2.

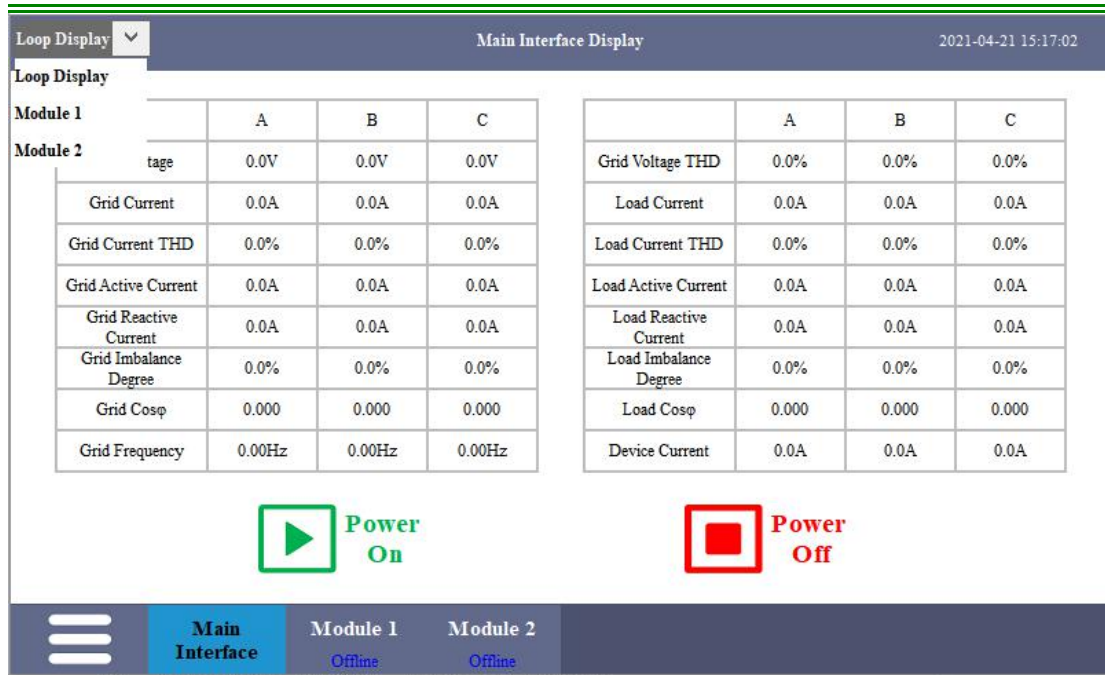

Figure 2-2 Main Interface Display Selection

2.2 Module Data Display

Click the corresponding module at the bottom of the interface to enter the module data display interface, as shown in Figure 2-3. The module data display interface displays voltage and current data, module output current, IGBT temperature, and the software version and hardware version of the module.

The operating status of the module is displayed in the upper left corner of the interface, including offline, standby, startup, running, fault, etc. The power-on and power-off buttons of the current module can turn on/off the current module.

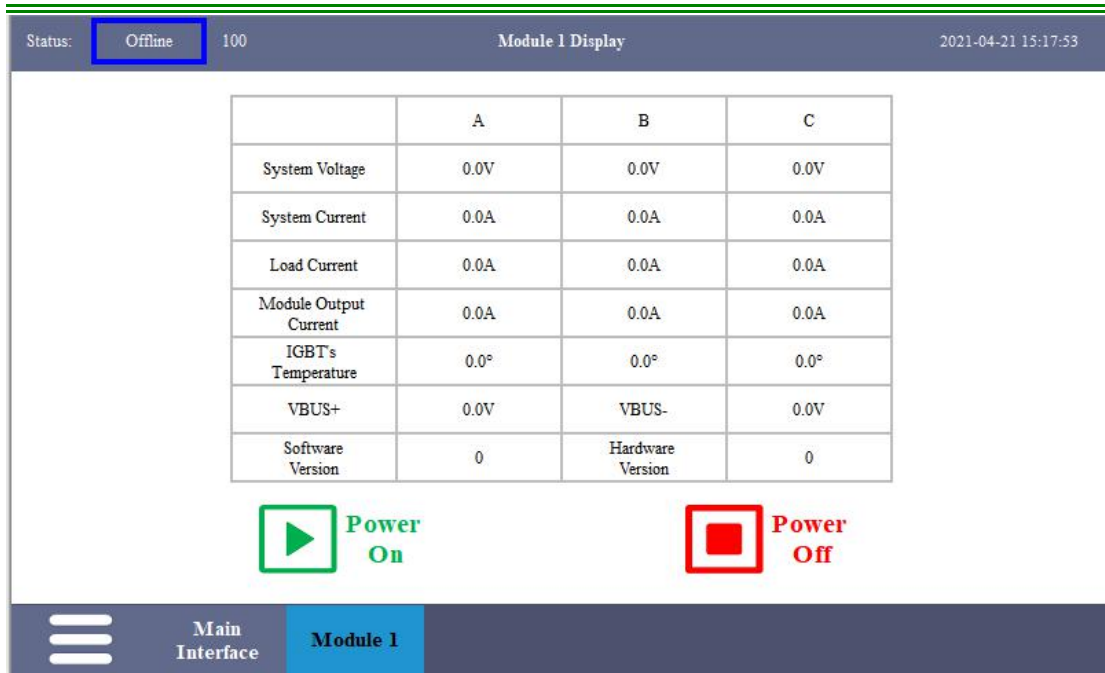

Figure 2-3 Module 1 Display

2.3 Main Menu

Click the main menu button in the lower left corner of the interface, and the menu bar options shown in Figure 2-4 will pop up, including parameter settings, data display, event log, and system setting.

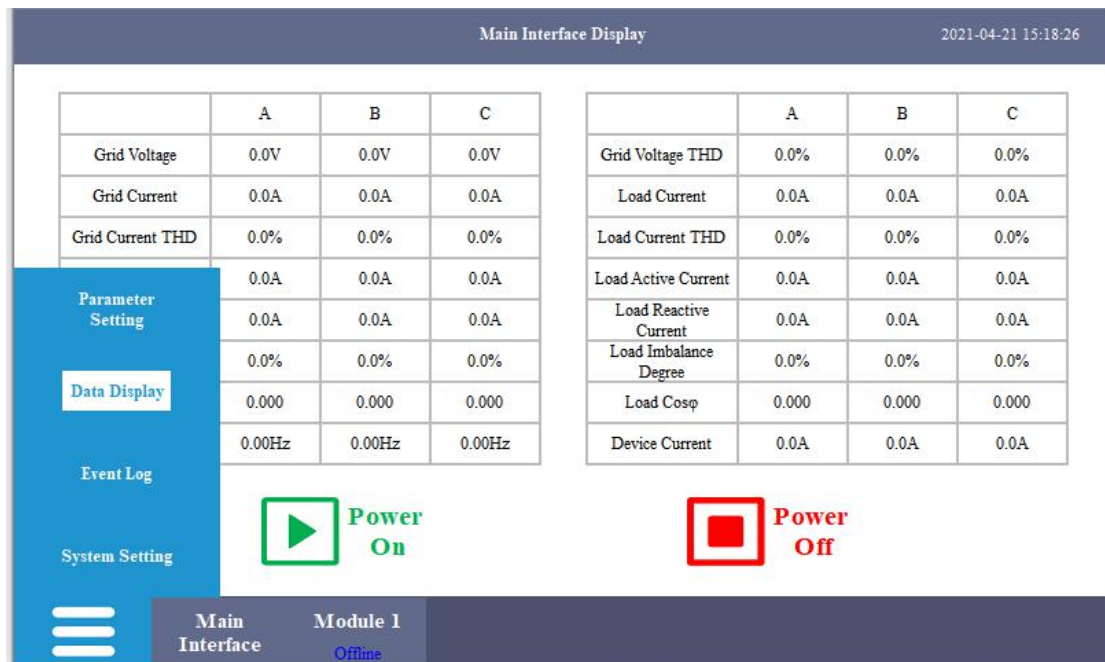

Figure 2-3 Main Menu

3. Parameter Setting

3.1 Main Parameter Setting

Click the parameter setting option in the main menu at the lower left corner of the interface, and the password input interface will pop up, as shown in Figure 3-1. After entering the password "8888", you will enter the main parameter setting interface, as shown in Figure 3-2.

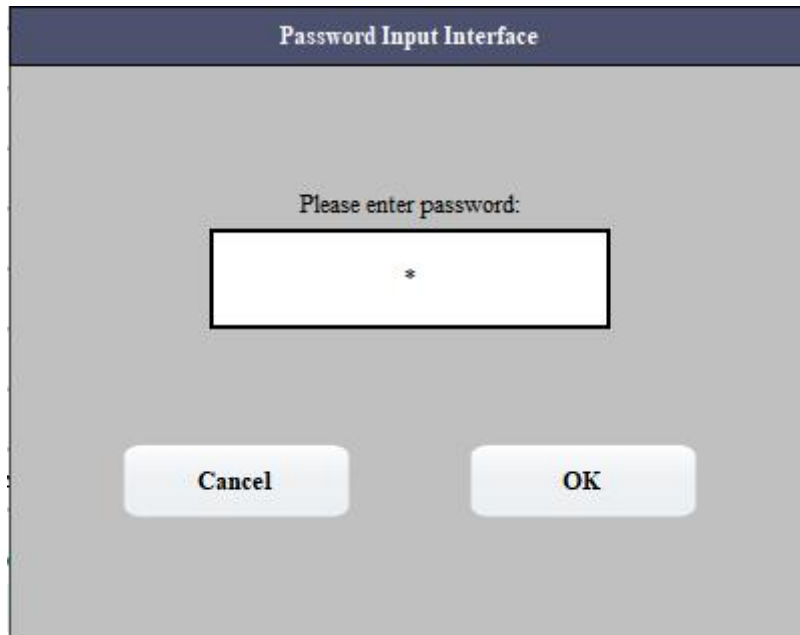

Figure 3-1 Password Input Interface

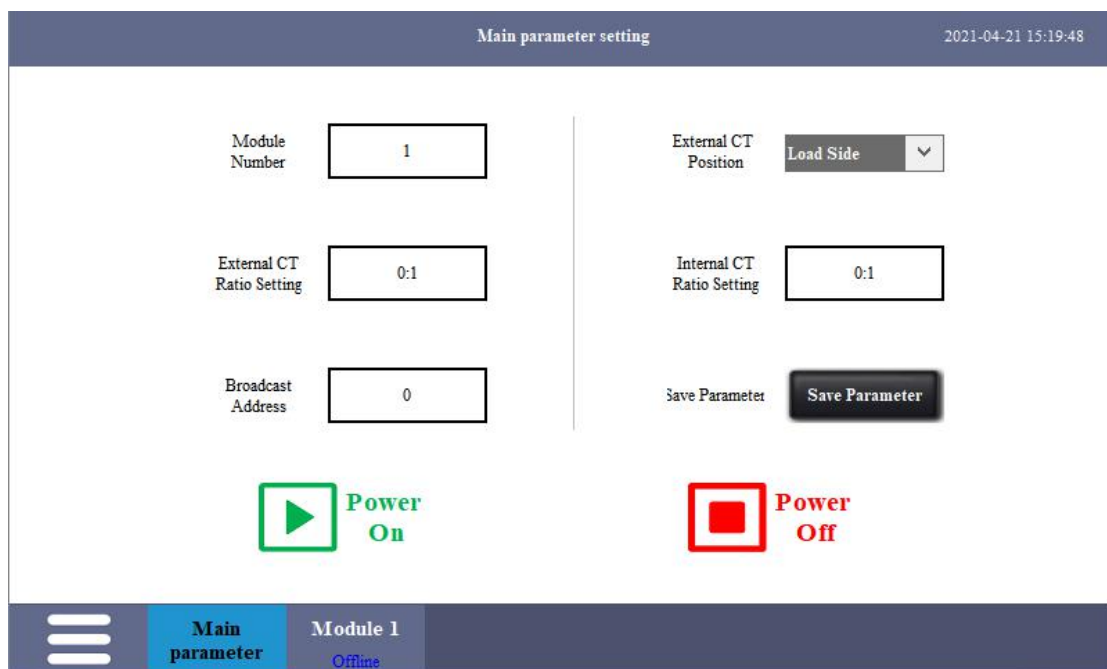

Figure 3-2 Main Parameter Setting

(1) Module Number

According to the setting of the number of LCD control modules, the number of modules must be entered first, and up to 6 modules can be set.

(2) CT Ratio Setting

The CT ratio setting is divided into external CT and internal CT. The external CT samples the grid current and is generally installed on the incoming cabinet or through the busbar. The internal CT is generally installed inside the filter cabinet to measure the total output current of the APF module. The CT ratio is set according to the actual ratio of the current transformer. If the current on the secondary side of the transformer is 1A, input the transformation ratio directly. If the transformation ratio is 200:1, input 200 directly; If the current on the secondary side of the transformer is 5A, the input transformation ratio value needs to be divided by 5. If the ratio is 800:5, input 160.

Note: When using a single module, do not install the internal transformer, at this time the internal CT ratio must be set to 0, otherwise it will cause inaccurate display of some data on the main interface.

(3) Selection of External CT Location

The position of the external CT is divided into the load side and the power side, which can be selected according to the actual installation position of the external CT.

Power supply side: The external CT is located between the transformer and the module, and the current sampled by the transformer includes the module current;

Load side: the external CT is located between the module and the load, the current sampled by the transformer does not include the module current.

(4) Broadcast address

Used to set the module address. When the module has no DIP switches or the DIP switches are damaged (set the DIP switches to 0), connect one module to the

LCD screen separately, and disconnect the RS485 communication of other modules from the LCD screen or disconnect the power supply of other modules. Enter the target address to be changed in the broadcast address input box. If you enter 2 in the broadcast address input box, you can change the module address to 2, and then check the module data and set parameters in the module 2 display or setting interface below.

(5) Power On/Off

Power on/off all modules controlled by the LCD screen.

(6) Save Parameter

After setting the parameters, click Save Parameters to save the parameters of all modules controlled by the LCD screen.

Note: When setting the parameters, the module needs to be in the standby state, and the parameters cannot be set while the device is running.

3.2 Module Parameter Setting

After the main parameter setting is completed, the parameters of a single module need to be set. Click the corresponding module at the bottom of the interface to enter the parameter setting interface, as shown in Figure 3-3.

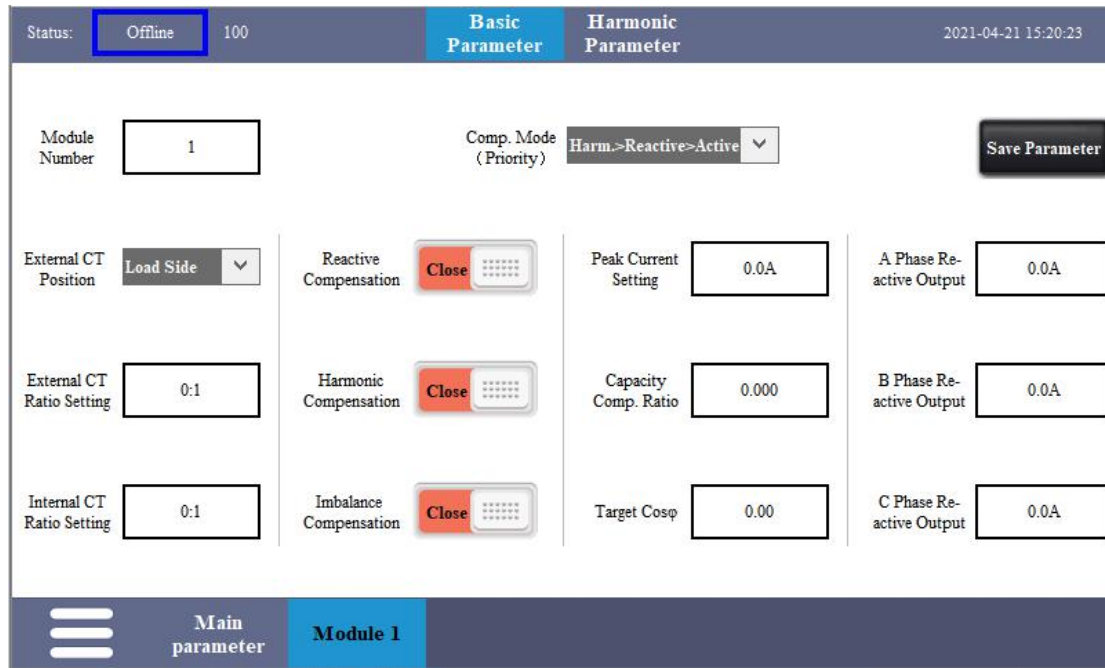

Status: Offline 100		Basic Parameter		Harmonic Parameter		2021-04-21 15:20:23	
Module Number	1	Comp. Mode (Priority)		Harm.>Reactive>Active		Save Parameter	
External CT Position	Load Side	Reactive Compensation	Close	Peak Current Setting	0.0A	A Phase Reactive Output	0.0A
External CT Ratio Setting	0:1	Harmonic Compensation	Close	Capacity Comp. Ratio	0.000	B Phase Reactive Output	0.0A
Internal CT Ratio Setting	0:1	Imbalance Compensation	Close	Target Cosp	0.00	C Phase Reactive Output	0.0A

Figure 3-3 Module Parameter Setting

The number of modules in the basic parameter setting interface of module 1, the selection of external CT positions, and the setting of internal and external CT ratios are exactly the same as those in the main parameter setting interface. If there is no special requirement, there is no need to repeat the setting after the main parameter interface setting is completed. Other setting options are as follows:

(1) Compensation Mode (priority)

Compensation mode (priority) is used to determine the priority of harmonic compensation, reactive power compensation and imbalance compensation. There are six modes in total. The drop-down box is shown in Figure 3-4. For example, Harm>Reactive>Active means that the harmonic compensated first, the reactive power compensation is the second, and the active power is compensated last.



Figure 3-4 Compensation Mode(priority)

(2) Reactive Compensation Switch

Turn on/off the reactive compensation function. When the reactive compensation function is turned on, the A/B/C phase reactive power output value must be zero.

(3) Harmonic Compensation Switch

Turn on/off the harmonic compensation function. When the harmonic compensation function is turned on, the A/B/C phase reactive output value must be zero.

(4) Imbalance Compensation Switch

Turn on/off the imbalance compensation function. When the unbalance compensation function is turned on, the A/B/C phase reactive power output value must be zero.

(5) Peak Current Setting

Multiply the capacity of the module by the required multiple in the input box. Such as 100A module, you can input 250A (2.5 times).

(6) Capacity Compensation Ratio

Set the capacity compensation ratio of the module, usually the ratio of the current module capacity to the total capacity of all parallel modules (range 0.000~1.000).

(7) Target Power Factor

Enter the corresponding target power factor in the input box as required.

(8) A/B/C Phase Reactive Power Output

This function is to actively output reactive power, and the reactive power output value is used to control the size of the reactive current output. The reactive power compensation function, harmonic compensation function and imbalance compensation function must be turned off at the same time to input the corresponding value in the input box of the three-phase reactive power output value. After the module is started, it will output the corresponding reactive current.

(9) Harmonic Number Compensation Ratio

Click the harmonic parameter at the top of the interface to enter the harmonic compensation ratio setting interface of each number, as shown in Figure 3-5. According to site requirements, enter the compensation ratio on the right side of the corresponding harmonic number, and the compensation ratio is generally set to 100%.

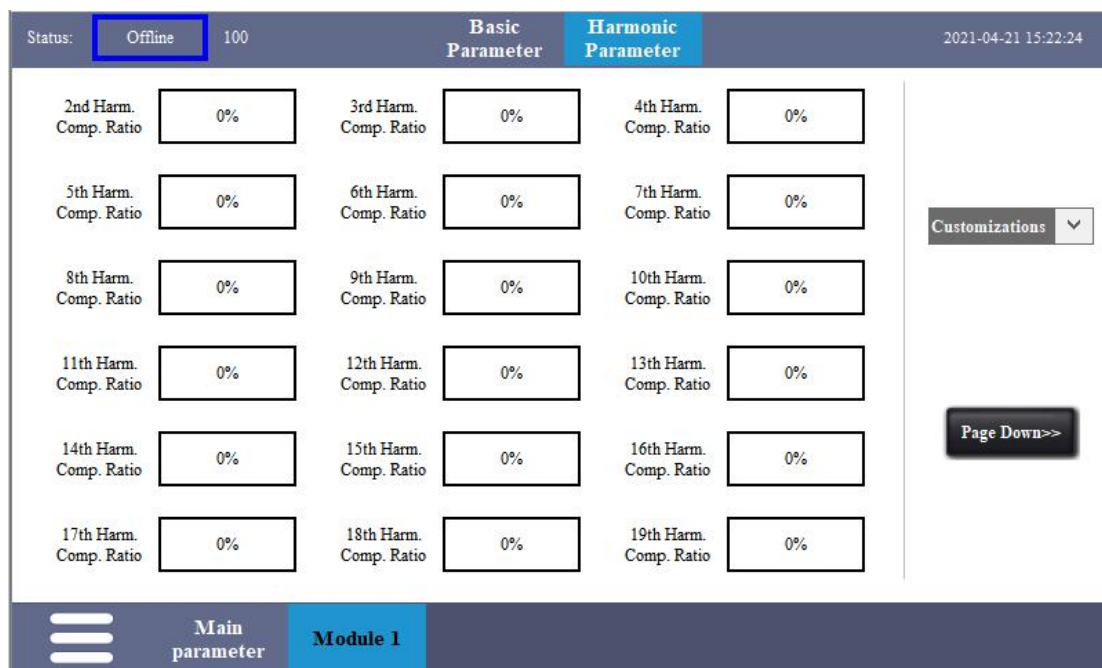

Figure 3-5 Harmonic Number Compensation Ratio

In the drop-down box on the right side of the interface, you can quickly select the compensation ratio of each number. The drop-down box (except for custom) has six options, namely 21/51st harmonic full compensation, 21/51st harmonic only compensation Odd number, 21/51st harmonic only compensation Even number, as shown in Figure 3-6.

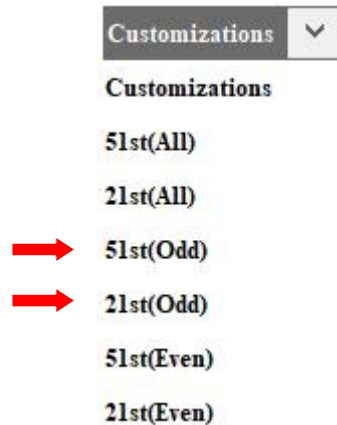

Figure 3-6 Harmonic Number Compensation Drop-down Box

(10) Save Parameter

After setting the module parameters, click Save Parameter to save the current module parameters.

4. Event Log

Click the event log option in the main menu at the lower left corner of the interface to enter the interface as shown in Figure 4-1. The event log interface can view the power on and off of each module and the faults that occurred during equipment operation, including the detailed time of the event, event code, event name, and key parameters, etc.

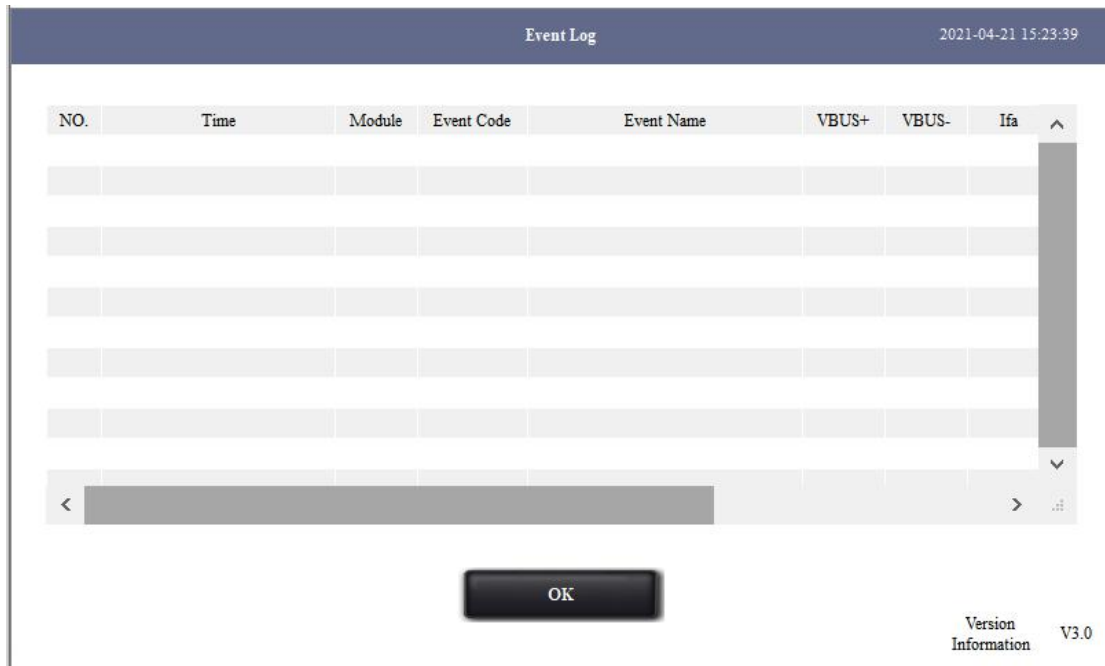

Figure 4-1 Event Log Interface

5. System Setting

Click the system setting option in the main menu at the lower left corner of the interface to enter the interface as shown in Figure 5-1. The system settings are mainly LCD screen language selection, time setting and address setting.

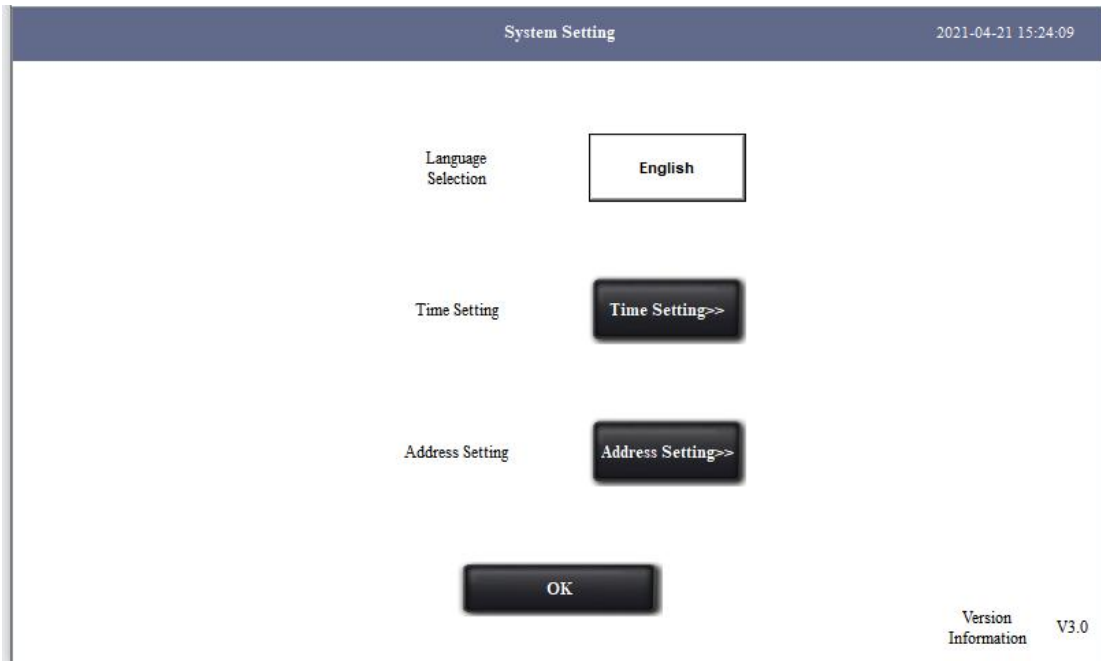

Figure 5-1 System Setting Interface

Click on the time setting, and the time setting interface will pop up, as shown in Figure 5-2, and then enter the time to be changed as required.

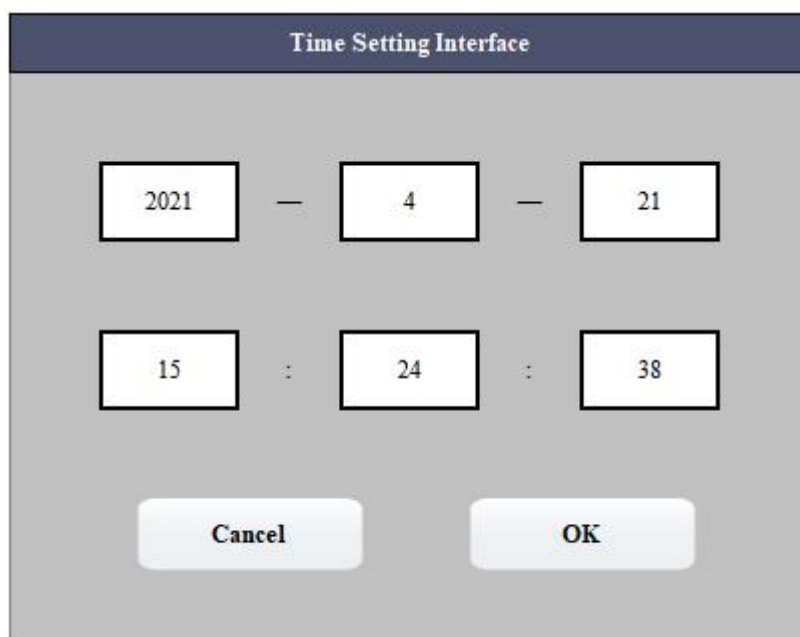

Figure 5-2 Time Setting Interface

Click the address setting, the LCD screen address setting interface will pop up, as shown in Figure 5-3, the default communication addresses of modules 1~6 in the LCD screen are 1~6 respectively. It can be modified according to requirements, but it must be ensured that the communication address is not repeated and that the communication address of the LCD screen is set to be consistent with the address of the module before communication can be established. For example, if there is an existing module with address 3, you can directly view the data and set parameters in the interface of module 3; you can also change the communication address of module 1 on the LCD screen to 3, and the communication address of module 3 to other values that are not repeated. Then view the data and set the parameters in the interface of module 1.

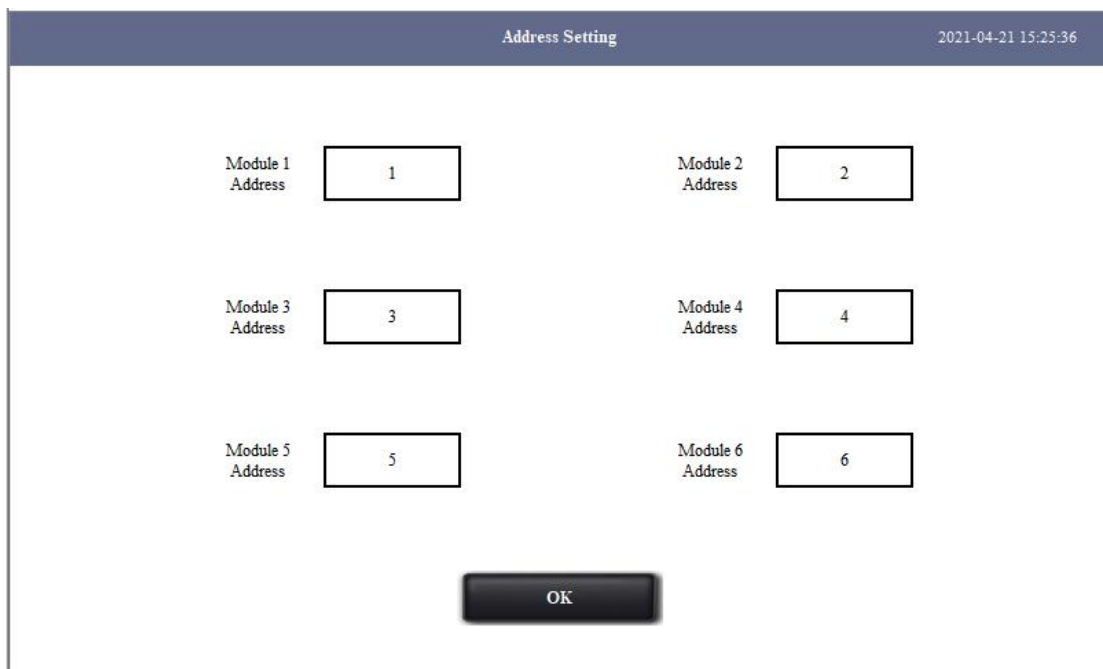

Figure 5-3 Address Setting Interface